

WD-Z2

Wireless Data Acquisition System



WDT-6M $\Phi 60$ Fits LME

WDT-5E $\Phi 50$ Fits LE

Wireless Network

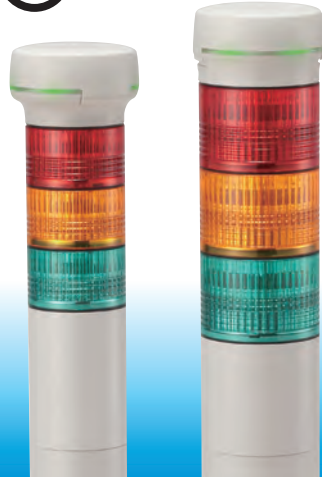

Monitor remotely and collect data wirelessly from a PATLITE Signal Tower

PATLITE wireless add-on modules and receivers make PATLITE Signal Towers capable of sending electrical signals over a wireless network to a data center. PATLITE wireless add-on modules and receivers are a uniquely practical and economical solution for data acquisition, machine status remote monitoring, and supervisory control of industrial processes. The WD-Z2 is an effective solution for lean manufacturing and a visual factory. PATLITE wireless add-on modules comply with IEEE802.15.4, operating in the 2.4 GHz band.

- 1) Simply add-on to a PATLITE Signal Tower
Operating conditions of Patlite signal towers installed on production machines or process systems can be transmitted wirelessly to a data center. Data acquisition and remote monitoring are possible instantly and economically through the WDR-Z2 receiver.
- 2) Wireless technology of today eliminates tedious wire installation
The WDT-Z2 add-on wireless modules tap their power from the PATLITE Signal Towers and transmit their electrical signals to the data center. This can reduce wiring, component installation and other related costs.
- 3) Multi-hopping topology and high transmitting reliability
With wireless multi-hopping, it minimizes potential transmitting failures or errors, adding a high level of stable operation and transmission reliability.

Dimensions (Unit: mm)

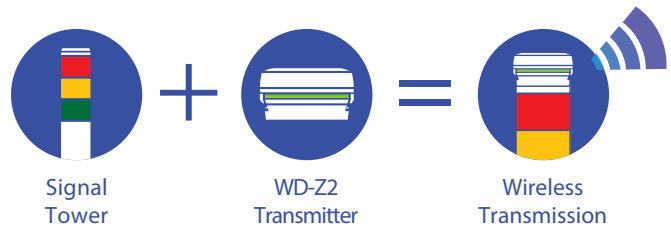
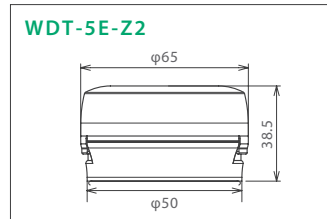
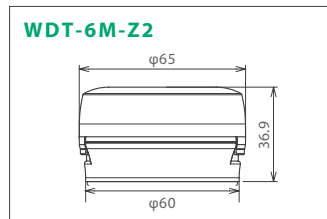
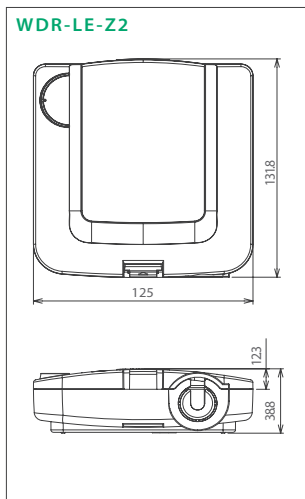

Typical Applications

- Multiple stand-alone machines can be networked by the WD-Z2 for data archiving and remote monitoring.
- The status and condition of the machines are indicated by the PATLITE signal towers.

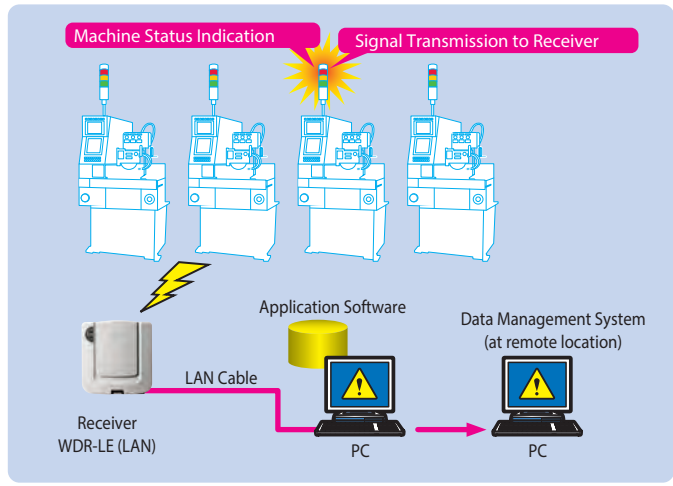

Wireless Concept IEEE 802.15.4 2.4GHz

- Wireless hopping/routing functions and mesh topology can make flexible and reliable wireless network configurations possible.
- Data archived by the WD-Z2 is stored in a file format CSV which any off-the-shelf data management software e.g. SCADA can handle.

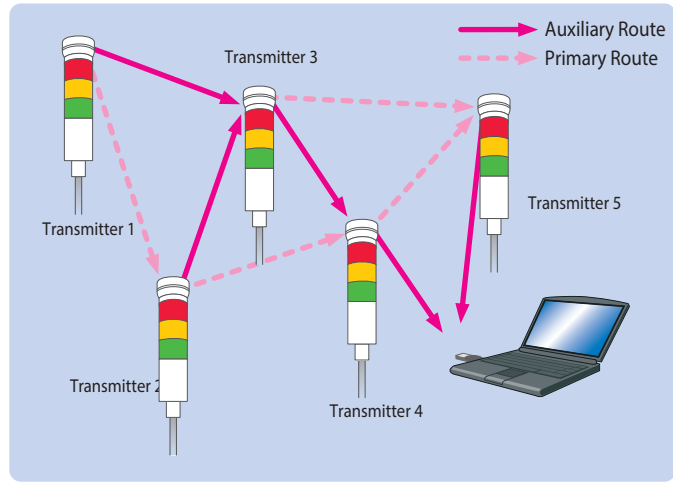

Network Connection Condition

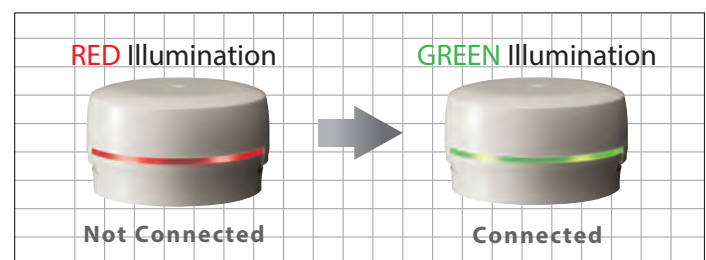

※ The transmitter is designed for PATLITE Model Series LME and LE Signal Towers. (As of Dec, 2012)

Transmitter Installation

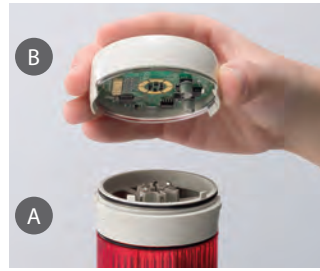

Affix the transmitter adaptor **A** on the Signal Tower and fasten it with the center screw. Then simply attach the transmitter **B** to the bracket. (Some applications don't require additional wiring.)

Specifications

Transmitters

Model	WDT-6M-Z2	WDT-5E-Z2
Applicable Signal Tower	Φ60 LME Series	Φ50 LE Series
Rated Voltage	DC 24V (No Polarity)	
Voltage Range	20.4V - 26.4V DC	
Current Consumption	35mA	
Operating Temperature	-10°C - +60°C (No Condensation)	
Storage Temperature	-20°C - +70°C (No Freezing)	
Relative Humidity	RH 85% or less	
Mounting Direction	Upright Position (Indoors Only)	
Protection Rating	Determined by PATLITE Signal Tower IP Ratings	
Dimensions (mm)	Φ65 x 36.9	Φ65 x 38.5
Mass	55g	

Ask your PATLITE Sales Representative for WD-Z2 compatible PATLITE Signal Towers

Receiver

Model	WDR-LE-Z2 (LAN/USB)
Rated Voltage	DC 24V (Power Supply not included)
Voltage Range	DC 20.4V - 26.4V
Current Consumption	150mA
Operating Temperature	-10°C - +60°C (No Condensation)
Storage Temperature	-20°C - +70°C (No Freezing)
Relative Humidity	RH 85% or less
Mounting Direction	Horizontal, Wall-mount (Indoors Only)
Protection Rating	IP20
Dimensions (mm)	131(H)x125(W)x38.5(D)
Mass	165g

Features

Wireless Standard	IEEE 802.15.4 for Zigbee 2.4GHz
Frequency Bandwidth	2,400MHz - 2,483.5MHz (16 Channels at 5MHz Step starting from 2,405MHz)
Networking Connections	up to 20 Units (*1)
Antenna Output	Maximum 1mW
Compliances	Wireless Telegraph Law, Electrical Appliance and Material Safety Law (AC Adaptor), RoHS, CE (R&TTE), FCC, China, Indonesia, Taiwan, Thailand, Phillipines
(*1) Number of possible Units to connect is based on the wireless environment and installation location	

- * This product operates on a frequency in compliance to FCC laws in the United States and its territories. Radio Laws for individual countries vary, and it is, therefore, the responsibility of the customer to comply with the laws in the country which applies to the application. Our company takes no responsibility directly, or indirectly, for claims from a customer or third party regarding Radio Laws or Wireless ordinance.
- * This product requires application software for configuration and data acquisition. For more information on the latest software and solution to fit the application, please contact your nearest PATLITE Sales Representative indicated on the backside of this Catalog.